

**Loud Speaker (External Magnet)**

**Model: LEU87R-31H10W4N**



**ELECTRICAL SPECIFICATIONS**

	Condition	Parameter	Unit
Sound Pressure Level	at 1.0W, 1.0M [at 0.6, 0.8, 1.0, 1.2KHz]	81 ± 3	dB
Impedance	at 1V, 800Hz	4 ± 15%	Ω
Rated Input Power		10	W
Max Input Power		12	W
Resonant Frequency (Fo)	at 1V	160 ± 20%	Hz
Frequency Range		Fo ~ 20000	Hz
Buzzer & Rattles	not be audible at sine wave between Fo ~ 20KHz	6.32	V
Operating Temperature		-25 ~ 70	°C
Magnet		Ferrite	
Frame Material		Metal	
Cone Material		Paper	
Weight		253	g

**MECHANICAL DRAWING**

Dimensions in mm

Tolerance ±0.5mm Except Specified

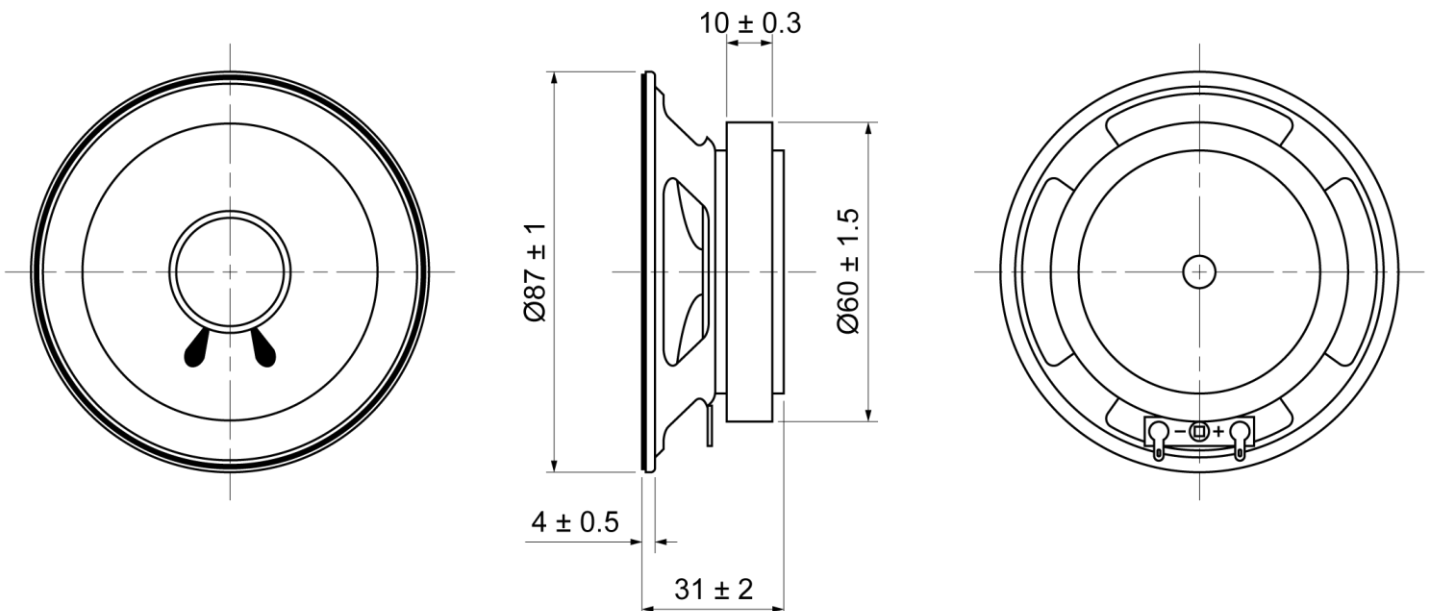

**Loud Speaker (External Magnet)**  
**Model: LEU87R-31H10W4N**

**FREQUENCY RESPONSE CURVE**

